



# RAM<sup>®</sup> MOUNTS

Powersports



# About RAM® Mounts

RAM® Mounts manufactures rugged and versatile mounting systems for cameras, tablets and other mobile devices that can be attached nearly anywhere. Unlike other mounts on the market, RAM® allows you to mount items where you need them most. The unique design of the RAM® Mounts system provides quick installation, adjustability, strength, vibration damping and durability—all at a low cost. Backed by a lifetime warranty, RAM® uses powder-coated marine-grade aluminum with lightweight and high-strength composites, stainless steel hardware and rubber balls.

## The RAM® Difference

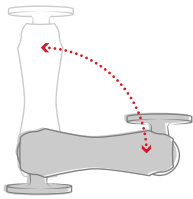

### Premium Design

The rubber ball and socket design of our mounting systems offers a secure hold, with near-infinite adjustability and vibration damping for the most demanding environments. With thousands of components trusted by users around the world, we've been able to design and develop mounting solutions that consumers and companies previously only dreamed were possible.

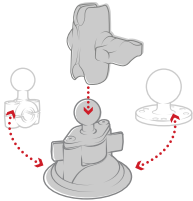

### Customizable

Take your phone mount from your truck to your boat, or mix and match components to create your ideal mount. Because of the modularity of the RAM® system, you can customize your solution to fit your specific needs in almost any application.

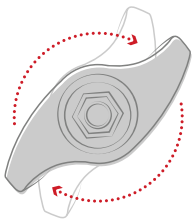

### Quality Materials

A premium design deserves the highest quality materials available, from rubber and stainless steel to high-strength composites and marine-grade aluminum. Our facilities—including powder coating, die casting, rubber injection molding, and shock and vibration testing—help us deliver on this promise to bring you inventive mounting solutions.

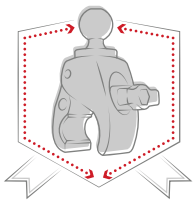

### Lifetime Warranty

It's simple. Our reputation as the leader of premier mounting systems means if we build it, then we guarantee it. We're confident in the quality of our products, and with our warranty, you can be too. Learn more [[link: rammount.com/warranty](http://rammount.com/warranty)] about our lifetime warranty.



# Our Partners

Here at RAM® Mounts, we believe that unfathomable things are possible with ingenuity. With a portfolio of over 5,000 SKUs paired with innovative engineers and in-house product experts, we have the tools and expertise needed to create solutions that you didn't know were possible. We have the ability to solve your mounting challenges quickly, efficiently and cost effectively.

No matter your company's size, you can trust RAM® Mounts to deliver ingenious solutions that do exactly what you need them to do.



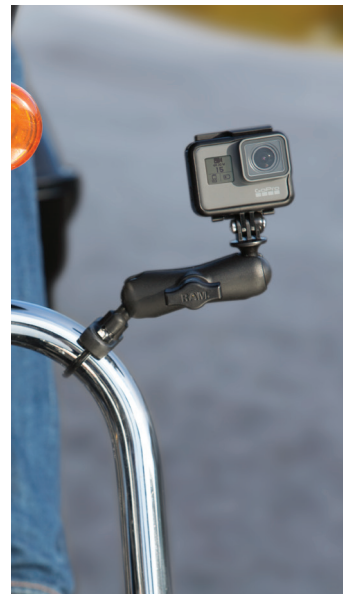
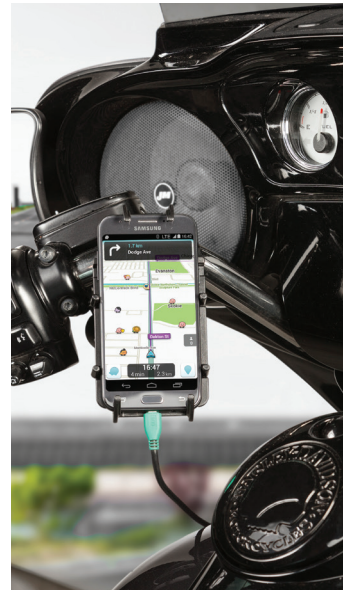



# Table of Contents

5 How It Works

6 Build a Mount

7 Popular Mounting Locations

11 Bases

27 Arms

29 Arm Accessories

31 Device Holders & Adapters

47 Power Accessories

49 Scooters

50 ATV/Side-by-Sides

51 Dirt Bikes

52 Snowmobiles



# How It Works

1

## Choose a Device Adapter

RAM® offers a wide selection of adapters and cradles for your specific device.

2

## Choose an Arm

Select an arm based on your desired length and placement.

3

## Choose a Base

Select from a variety of bases to help secure your device where you need it.

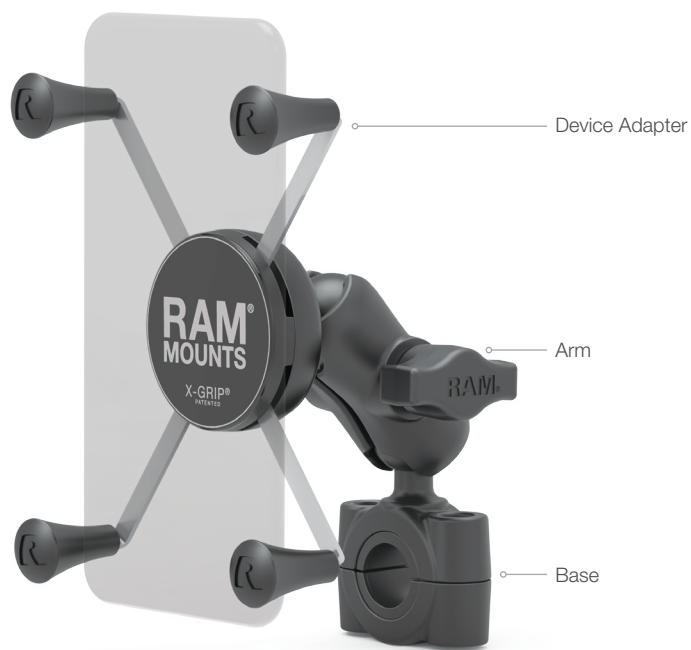

## Modular Solutions for Every Use

### Slip Resistant

The marine-grade aluminum and composite arm provides a strong hold that reduces slip on the rubber ball

### Guaranteed

RAM® Mounts offers a lifetime warranty on all mounting hardware

### Vibration Damping

The rubber ball absorbs the impact of the road, providing shock and vibration damping

### Adjustable

With nearly 360 degrees of articulation, each product may be adjusted to any angle with the turn of a single knob



# Build a Mount

## 1 | Choose a Device Adapter



**RAM-HOL-UN7B**  
RAM® X-Grip® Holder for Phones up to 3.25" Wide



**RAM-HOL-UN12WB**  
RAM® Tough-Charge™ Wireless Charger with X-Grip® Technology



**RAP-B-202-GOP1**  
Action Camera Ball Adapter



**RAP-B-417B**  
RAM® Level Cup™ XL

## 2 | Choose an Arm



**RAM-B-201-A**  
2.42" Short Socket Arm



**RAM-B-201**  
3.73" Medium Socket Arm



**RAM-B-201U-C**  
6" Long Socket Arm



**RAP-B-200-12U**  
4.25" Socket Swivel Arm

## 3 | Choose a Base



**RAM-B-408-75-1**  
.75" - 1" Handlebar  
RAM® Torque™ Base



**RAM-B-309-7**  
Brake/Clutch Reservoir Base



**RAM-B-342**  
Center Fork Stem Base



**RAM-B-231Z**  
.5" - 1.25" Handlebar U-Bolt Base

# Popular Mounting Locations



1



RAM® Torque™ Base  
pg. 12

2



Brake/Clutch Reservoir Base  
pg. 16

3



RAM® Tough-Ball™ Base  
pg. 26

4



U-Bolt Handlebar Base  
pg. 14



# Popular Mounting Locations



1



Threaded Ball Adapter  
pg. 25

2



Small RAM® Tough-Claw™ Base  
pg. 20

3



Handlebar Clamp Base  
pg. 21

# Popular Mounting Locations



1



RAM® Torque™ Base  
pg. 12

2



Bolt Head Flat Base  
pg. 22

3



Reservoir Cover Base  
pg. 24

# Popular Mounting Locations

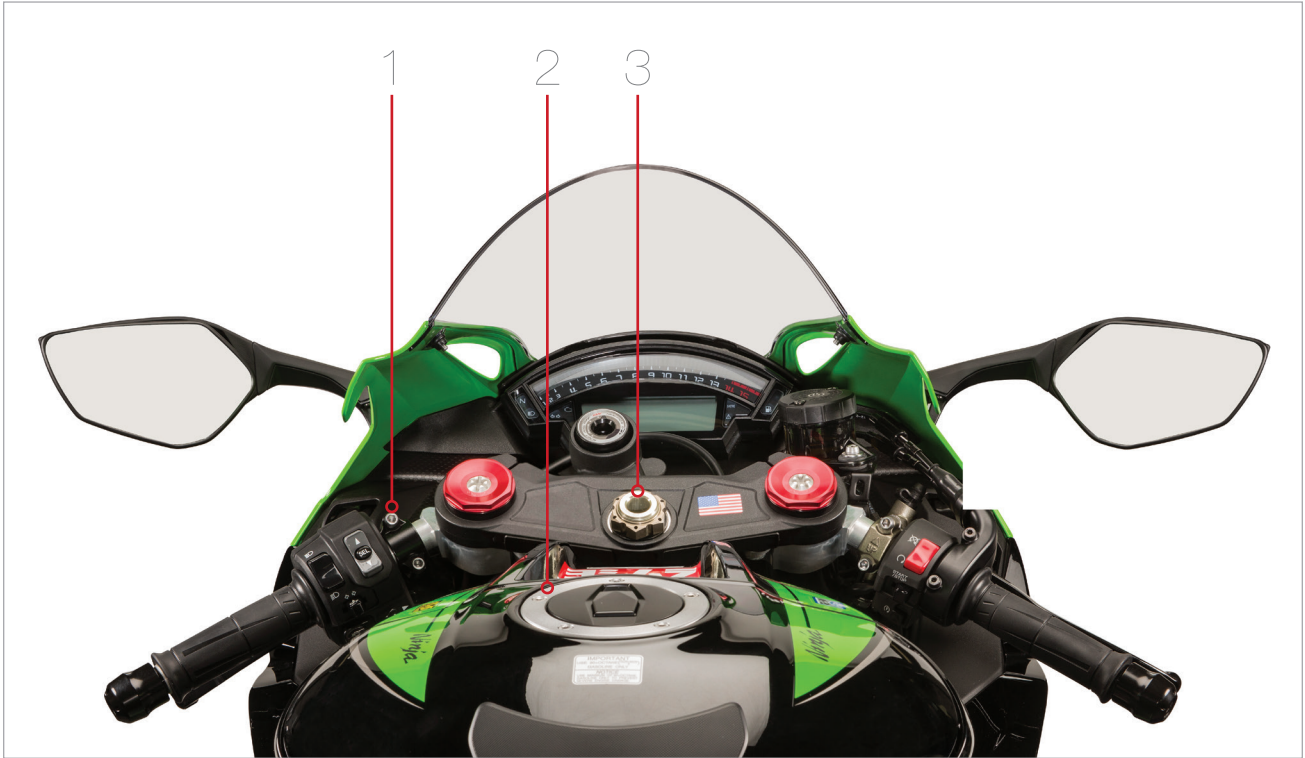

1



Brake/Clutch Reservoir Base  
pg. 16

2



Gas Tank Base  
pg. 23

3



Fork Stem Base  
pg. 18



---

# Bases



Seen in this photo:  
RAM-B-408-75-1-UN7, RAM® Torque™ Handlebar/Rail Mount with RAM® X-Grip® Phone Holder (shown with Samsung Galaxy S5)

# Bases

## RAM® Torque™ Handlebar Base

RAM® Mounts Torque™ bases fit a variety of rail and bar sizes for secure placement of your device. Sizing inserts create a tight hold while protecting the bar, and the cast aluminum mount is available with a 1" or 1.5" rubber ball that attaches to a RAM® arm. Mount your GPS unit, camera, phone or tablet to handlebars, roll cages or even mirror posts.

Part Number	Diameter Range	Ball Size
RAM-B-408-37-62	.375" - .625"	1" (B)
RAM-B-408-75-1	.75" - 1"	1" (B)
RAM-B-408-112-15	1.125" - 1.5"	1" (B)
RAM-408-75-1	.75" - 1"	1.5" (C)
RAM-408-112-15	1.125" - 1.5"	1.5" (C)



RAM-B-408-75-1



RAM-408-112-15

## Popular Kits

Utilize the RAM® Torque™ handlebar base to mount a number of devices with the RAM® X-Grip® and action camera adapter, or even a drink with the RAM® Level Cup™ and RAM® Level Cup™ XL.

Part Number	Device	Diameter Range	Socket Arm Length
RAM-B-408-37-62-A-UN7	Phones up to 3.25" Wide	.375" - .625"	Short (2.42")
RAM-B-408-37-62-UN7	Phones up to 3.25" Wide	.375" - .625"	Medium (3.73")
RAM-B-408-37-62-A-UN10	Phones up to 4.5" Wide	.375" - .625"	Short (2.42")
RAM-B-408-37-62-UN10	Phones up to 4.5" Wide	.375" - .625"	Medium (3.73")
RAM-B-408-75-1-A-UN7	Phones up to 3.25" Wide	.75" - 1"	Short (2.42")
RAM-B-408-75-1-UN7	Phones up to 3.25" Wide	.75" - 1"	Medium (3.73")
RAM-B-408-75-1-A-UN10	Phones up to 4.5" Wide	.75" - 1"	Short (2.42")
RAM-B-408-75-1-UN10	Phones up to 4.5" Wide	.75" - 1"	Medium (3.73")
RAM-B-408-75-1-A-GOP1U	Action Cameras (2-Prong)	.75" - 1"	Short (2.42")
RAM-B-408-75-1-A-132U	16oz Drinks	.75" - 1"	Short (2.42")
RAM-B-408-75-1-A-417	32oz Drinks	.75" - 1"	Short (2.42")
RAM-B-408-112-15-UN7	Phones up to 3.25" Wide	1.125" - 1.5"	Medium (3.73")
RAM-B-408-112-15-A-UN10	Phones up to 4.5" Wide	1.125" - 1.5"	Short (2.42")
RAM-B-408-112-15-UN10	Phones up to 4.5" Wide	1.125" - 1.5"	Medium (3.73")
RAM-B-408-112-15-A-GOP1U	Action Cameras (2-Prong)	1.125" - 1.5"	Short (2.42")
RAM-B-408-112-15-A-132U	16oz Drinks	1.125" - 1.5"	Short (2.42")
RAM-B-408-112-15-A-UN7	Phones up to 3.25" Wide	1.125" - 1.5"	Short (2.42")



RAM-B-408-75-1-A-UN7



RAM-B-408-112-15-A-UN10



RAM-B-408-75-1-A-417



RAM-B-408-112-15-A-GOP1U



## Bases



Seen in this photo:  
RAM-B-149Z-GOP1, U-Bolt Handlebar Mount with Universal Action Camera Adapter (shown with GoPro® HERO 5)



# Bases

## U-Bolt Handlebar Base

This base has a 1" diameter rubber ball designed to sit at right angles on the mounting rail. The zinc-coated and stainless steel U-bolts accommodate rails from .5" to 1.25" in diameter. Black caps are included to cover the exposed ends of the U-bolt and a composite adapter can narrow the minimum diameter of the rail to .5".

Part Number	Diameter Range	Color	Hardware
RAM-B-231Z	.5" - 1.25"	Black	Zinc
RAM-B-231	.5" - 1"	Black	Stainless Steel
RAM-B-231-1U	1" - 1.25"	Black	Stainless Steel
RAM-B-231CH	.5" - 1"	Chrome	Stainless Steel
RAM-B-231-1CHU	1" - 1.25"	Chrome	Stainless Steel



RAM-B-231Z



RAM-B-231CH

## Popular Kits

The U-Bolt handlebar base is an ideal solution to support the RAM® X-Grip® for phones, universal and Garmin VIRB action camera adapters, the magnetic RAM® Power Plate™ III for radar detectors, and much more.

Part Number	Device	Socket Arm Length
RAM-B-149Z-A-UN7U	Phones up to 3.25" Wide	Short (2.42")
RAM-B-149Z-UN7	Phones up to 3.25" Wide	Medium (3.73")
RAM-B-149Z-A-UN10U	Phones up to 4.5" Wide	Short (2.42")
RAM-B-149Z-UN10	Phones up to 4.5" Wide	Medium (3.73")
RAM-B-231Z-A-366U	Action Cameras (1/4"-20)	Short (2.42")
RAM-B-231Z-366	Action Cameras (1/4"-20)	Medium (3.73")
RAM-B-149Z-A-GOP1	Action Cameras (2-Prong)	Short (2.42")

Part Number	Device	Socket Arm Length
RAM-B-149Z-GOP1	Action Cameras (2-Prong)	Medium (3.73")
RAM-B-149Z-GA63U	Garmin VIRB Camera	Medium (3.73")
RAM-B-132R	16oz Drinks	Medium (3.73")
RAM-B-149Z-PD3	Phones (RAM® Quick-Grip™)	Medium (3.73")
RAM-B-149Z-UN4	Radios	Medium (3.73")
RAM-B-149Z-300-1U	Radar Detectors	Medium (3.73")
RAM-B-149Z-GUN1	Gun Holsters	Medium (3.73")



RAM-B-149Z-A-UN7U



RAM-B-149Z-UN10



RAM-B-149Z-A-GOP1



RAM-B-149Z-300-1U

## Bases



Seen in this photo:  
RAM-B-174-UN7, Brake/Clutch Reservoir Mount with RAM® X-Grip® Phone Holder (shown with Apple iPhone 7)

# Bases

## Brake/Clutch Reservoir Base

The combination handlebar and brake/clutch reservoir base provides the ultimate flexibility for mounting your device to your motorcycle. The kit contains standard and metric threaded stainless bolts as well as zinc-coated metal U-bolts accommodating rails from .5" to 1.25" in diameter.

Part Number	Color	Notes
RAM-B-309-1	Black	Single Ball
RAM-B-309-1CH	Chrome	Single Ball
RAM-B-309-2CH	Chrome	Double Ball
RAM-B-309-6U	Black	Double Ball
RAM-B-309-7	Black	Single Ball, optional U-Bolt hardware



## Popular Kits

With the brake/clutch reservoir base, keep your phone, action camera or even LED spotlight at your fingertips with the following compatible kits.

Part Number	Device	Socket Arm Length
RAM-B-174-A-UN7	Phones up to 3.25" Wide	Short (2.42")
RAM-B-174-UN7	Phones up to 3.25" Wide	Medium (3.73")
RAM-B-174-A-UN10U	Phones up to 4.5" Wide	Short (2.42")
RAM-B-174-UN10	Phones up to 4.5" Wide	Medium (3.73")
RAM-B-174-366	Action Cameras (1/4"-20)	Medium (3.73")
RAM-B-174-A-GOP1U	Action Cameras (2-Prong)	Short (2.42")
RAM-B-174-GOP1	Action Cameras (2-Prong)	Medium (3.73")

Part Number	Device	Socket Arm Length
RAM-B-174-GA63U	Garmin VIRB Camera	Medium (3.73")
RAM-B-174-A-132	16oz Drinks	Short (2.42")
RAM-B-132-309	16oz Drinks	Medium (3.73")
RAM-B-174-A-417	32oz Drinks	Short (2.42")
RAM-B-174-UN4	Radios	Medium (3.73")
RAM-B-174-300-1U	Radar Detectors	Medium (3.73")
RAM-B-174-152	LED Spotlight	Medium (3.73")





## Bases



Seen in this photo:  
RAM-B-342, Fork Stem Base  
RAM-B-201-A, Short Double Socket Arm  
RAP-B-202-GOP1, Universal Action Camera Adapter (shown with GoPro® HERO 5)

# Bases

## Fork Stem Base

The fork stem base is designed to fit and expand into the cylindrical bore wall of fork stems and will work with stems that measure 12 to 38mm (.5" to 1.49") in diameter. The base is made of powder-coated, marine-grade aluminum and includes a 1" diameter rubber ball.



RAM-B-342

## Popular Kits

Whether you need to mount your phone, action camera or radio, you'll find a compatible kit to get the job done. Secure your device with the RAM® X-Grip®, action camera adapter or RAM® Finger-Grip™.

Part Number	Device	Socket Arm Length
RAM-B-176-A-UN7	Phones up to 3.25" Wide	Short (2.42")
RAM-B-176-A-UN10U	Phones up to 4.5" Wide	Short (2.42")
RAM-B-342-366	Action Cameras (1/4"-20)	Medium (3.73")
RAM-B-176-GOP1	Action Cameras (2-Prong)	Medium (3.73")
RAM-B-176-UN4	Radios	Medium (3.73")



RAM-B-176-A-UN7



RAM-B-176-A-UN10U



RAM-B-176-GOP1



RAM-B-176-UN4



## Bases



Seen in this photo:  
RAM-B-400-A-HOL-UN10BU, RAM® Tough-Claw™ Mount With Short Arm and RAM® X-Grip® Phone Holder (shown with Apple iPhone 7 Plus)



# Bases

## RAM® Tough-Claw™

The RAM® Mounts Tough-Claw™ is the perfect mounting base for quick installation and removal on round, square and odd-shaped rails and bars – such as handlebars or roll cages. The RAM® Tough-Claw™ can be clamped on rails from .625" to 2.25" in diameter, making this an ideal solution for mounting tablets, action cameras, phones and much more.



**RAP-B-400**  
.625" - 1.5" Diameter

**RAP-B-404**  
1" - 1.875" Diameter

**RAP-B-401**  
1" - 2.25" Diameter

## Popular Kits

There are a wide variety of kits available for the versatile and durable RAM® Tough-Claw™, allowing users to take advantage of the RAM® X-Grip® phone cradle, RAM® Level Cup™ and RAM® Level Cup™ XL drink holders, and the RAM® EZ-Roll™ cradle for OtterBox uniVERSE cases.

Part Number	Device	Socket Arm Length
RAM-HOL-UN7-400	Phones up to 3.25" Wide	n/a (Low Profile)
RAM-B-400-A-HOL-UN7BU	Phones up to 3.25" Wide	Short (2.42")
RAM-B-400-UN7	Phones up to 3.25" Wide	Medium (3.73")
RAM-B-400-C-UN7U	Phones up to 3.25" Wide	Long (6")
RAM-HOL-UN7-400-1U	Phones up to 3.25" Wide	n/a (Low Profile)
RAM-HOL-UN10-400	Phones up to 4.5" Wide	n/a (Low Profile)
RAM-HOL-UN10-400-1U	Phones up to 4.5" Wide	n/a (Low Profile)
RAM-B-400-A-HOL-UN10BU	Phones up to 4.5" Wide	Short (2.42")
RAM-B-400-C-UN10U	Phones up to 4.5" Wide	Long (6")
RAM-B-400-OT2U	Apple iPhone with OtterBox uniVERSE Case	Medium (3.73")
RAM-B-400-A-366U	Action Cameras (1/4"-20)	Short (2.42")

Part Number	Device	Socket Arm Length
RAM-B-404-A-366U	Action Cameras (1/4"-20)	Short (2.42")
RAM-B-404-366U	Action Cameras (1/4"-20)	Medium (3.73")
RAM-B-400-A-GOP1U	Action Cameras (2-Prong)	Short (2.42")
RAP-B-400-GOP1	Action Cameras (2-Prong)	Medium (3.73")
RAP-B-404-GOP1U	Action Cameras (2-Prong)	Medium (3.73")
RAP-B-400-GA63U	Garmin VIRB Camera	Medium (3.73")
RAM-B-132-400	16oz Drinks	n/a (Low Profile)
RAP-B-417-400	32oz Drinks	n/a (Low Profile)
RAM-B-152-404	LED Spotlight	Medium (3.73")



**RAM-HOL-UN7-400**

**RAM-B-400-A-HOL-UN10BU**

**RAP-B-417-400**

**RAM-B-400-OT2U**

\*Fits with OtterBox uniVERSE Case

# Bases

## Handlebar Clamp Base

This 1" rubber ball base will replace an M8 by 25mm, 30mm or 35mm handlebar bolt. To determine compatibility, measure the bolt length and add 30mm to the length. Screw the ball base onto the handlebar top clamp using one of three included 1.25mm thread pitch bolts: M8 x 55mm, M8 x 60mm and M8 x 65mm.



## Popular Kits

The handlebar clamp base provides an excellent attachment point for the RAM® X-Grip® cradle, allowing you to easily secure your phone while on the road. Available in both standard and large sizes.



Seen in these photos:  
RAM-B-367, Handlebar Clamp Base  
RAM-B-201-A, Short Double Socket Arm  
RAM-HOL-UN7B, RAM® X-Grip® Phone Holder (shown with Samsung Galaxy S5)

# Bases

## Bolt Head Adapter Bases

The versatile flat base – with a bolt-down area of 2.25" x .875" x .2" – includes a 1" diameter rubber ball and an 11mm hole. The angled base version also includes a 1" diameter rubber ball and a 9mm hole, and a bolt-down area of 1.18" x .75" x .2". Both bolt head adapter bases are often attached to the mirror frame and fit well on exposed bolts.

Flat Base



**RAM-B-252**  
2.25" x .875" Plate 11mm Hole

Angled Base



**RAM-B-272**  
1.125" x .75" Plate 9mm Hole



Seen in this photo:  
RAM-B-252, Bolt Head Flat Base  
RAM-B-201-A, Short Double Socket Arm  
RAP-B-202-GOP1, Universal Action Camera Adapter (shown with GoPro® HERO 5)



Seen in this photo:  
RAM-B-272, Bolt Head Flat Base  
RAM-B-201-A, Short Double Socket Arm  
RAP-B-202-GOP1, Universal Action Camera Adapter (shown with GoPro® HERO 5)



# Bases

## Gas Tank Base

This base is a low-profile way to get a unique perspective from your action camera or to attach your device where it can be easily accessed. Hardware is included for mounting to the fill port for stock tanks on most popular makes, such as BMW, Honda, Kawasaki, Suzuki and Yamaha.

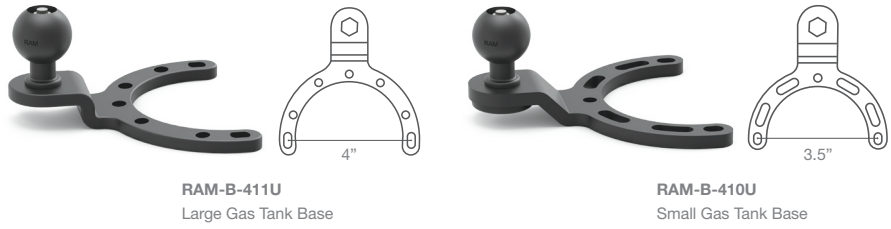

## Popular Kits

Securing your phone or action camera using the gas tank base is made easy with these kits. Both the RAM® X-Grip® and action camera adapter are available for the small and large versions of the gas tank base.

Part Number	Device	Gas Tank Size
RAM-B-410-A-UN7B	Phones up to 3.25" Wide	Small
RAM-B-411-A-UN7B	Phones up to 3.25" Wide	Large
RAM-B-410-A-UN10BU	Phones up to 4.5" Wide	Small
RAM-B-411-A-UN10BU	Phones up to 4.5" Wide	Large
RAM-B-410-A-GOP1U	Action Cameras (2-Prong)	Small
RAM-B-411-A-GOP1U	Action Cameras (2-Prong)	Large



Seen in this photo:  
RAM-B-410-A-UN10BU, Small Gas Tank Mount with RAM® X-Grip® Phone Holder (shown with Apple iPhone 6+)

# Bases

## Reservoir Cover Base

These bases fit over your existing brake/clutch reservoir cover with either a 1" offset ball or a 1" center ball. The plate dimensions for the center ball base measure 2.87" x 1.82", compared to 4" x 1.82" for the offset ball base.

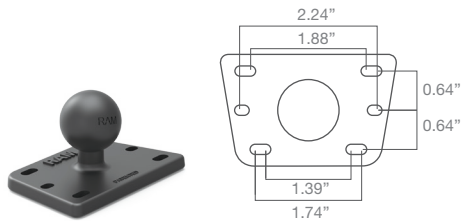

**RAM-B-345**  
Center Ball Base

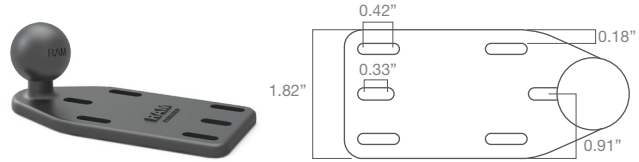

**RAM-B-346**  
Offset Ball Base



Seen in this photo:  
RAM-B-346, Offset Reservoir Cover Base  
RAM-B-201, Medium Double Socket Arm  
RAM-B-202, AMPS Round Device Adapter  
RAP-300-1, RAM® Power Plate™ III Radar Detector Holder (shown with Valentine One)



# Bases

## Threaded Ball Adapters

Take advantage of your unused mirror sockets with these threaded bases, available with a M10 x 1.25 pitch male thread or a M10 x 1.5 pitch male thread. Both bases feature a RAM® B size (1") ball so you can connect a wide range of mounting solutions.



**RAM-B-349**  
M10 x 1.25



**RAM-B-349-1U**  
M10 x 1.5



Seen in this photo:  
RAM-B-349, Threaded Ball Adapter  
RAM-B-201-A, Short Double Socket Arm  
RAM-HOL-UN7B, RAM® X-Grip® Phone Holder (shown with Apple iPhone 7)



## Bases

### RAM® Twist and Tilt™

The RAM® Twist and Tilt™ threads into the stock mirror location, giving users the ability to twist the mount 360 degrees, while the 1" ball can be tilted 180 degrees. Designed to be discrete and made of die cast marine-grade aluminum, this versatile pivot base provides numerous mounting possibilities.



RAM-B-360

### RAM® Tough-Ball™ for Harley Davidson

This low-profile mounting base is designed to mount directly through the mirror holes on a standard Harley-Davidson. The included barrel nut enables you to mount the ball on top or below the hand grips where the mirror holes are located, helping to ensure a clear line of sight.



RAP-B-379-HA1U



Seen in this photo:  
RAP-B-379-HA1U, RAM® Tough-Ball™ for Harley Davidson  
RAM-B-201, Medium Double Socket Arm  
RAP-B-202-GOP1, Universal Action Camera Adapter (shown with GoPro® HERO 5)

---

# Arms



Seen in this photo:  
RAM-B-309-7, Brake/Clutch Reservoir Base  
RAM-B-201, Medium Double Socket Arm  
RAM-HOL-UN7B, RAM® X-Grip® Phone Holder (shown with Apple iPhone 7)



# Arms

---

## Black Arms

Available in short, standard and long sizes, RAM® Mounts B size double socket arms accommodate 1" ball bases. RAM® ball and socket technology allows for near infinite adjustability.



**RAM-B-201-A**  
Overall length: 2.38"  
Socket-to-socket: 1.75"



**RAM-B-201**  
Overall length: 3.69"  
Socket-to-socket: 3"



**RAM-B-201-C**  
Overall length: 6"  
Socket-to-socket: 5.25"

---

## Chrome Arms

Almost all RAM® Mounts you've seen have likely been all black. But our chrome double socket arms—available only in B size (1") - are the perfect match for motorcycle handlebars.



**RAM-B-201-ACH**  
Overall length: 2.38"  
Socket-to-socket: 1.75"



**RAM-B-201CH**  
Overall length: 3.69"  
Socket-to-socket: 3"

---

## Swivel/Ratchet Arms

The double socket swivel arm consists of two 1" open ball sockets with a 360 degree rotation point at the center of the arm. With the multi-pivot arm, a connected swivel joint rotates 180 degrees.



**RAM-B-200-12U**  
Overall length: 4.25"  
Socket-to-socket: 3.625"



**RAM-B-200-2**  
Overall length: 6.25"  
Socket-to-socket: 5.625"



---

# Arm Accessories



Seen in this photo:  
RAM-B-408-112-15-238U, RAM® Torque™ Handlebar Mount  
RAM-HOL-PD3, RAM® Quick-Grip™ Phone Holder  
RAM-B-273, RAM® Add-A-Ball™ Accessory  
RAM-B-201-A, Short Double Socket Arm  
RAP-B-202-GOP1, Universal Action Camera Adapter (shown with WASPcam 9905 Wi-Fi)

# Arm Accessories

## Adapters

With the RAM® Mounts Add-A-Ball™, connect another device to your existing mount by utilizing another 1" ball. To connect two arms, use the RAM® double ball adapter.

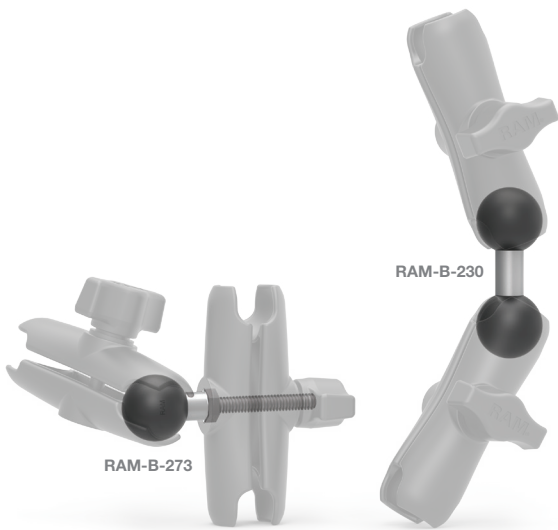

## RAM® Pin-Lock™ Security Knobs

Using a female threaded security knob and key knob, the mixed combination RAM® Pin-Lock™ security knob can replace all knobs on B (1") and C (1.5") size arms and mounts to prevent theft and tampering of your electronics.

Part Number	Ball Size
RAP-S-KNOB3	1" (B)
RAP-S-KNOB5	1.5" (C)



Seen in this photo:  
 RAM-B-149Z-UN7, U-Bolt Handlebar Mount With RAM® X-Grip® Phone Holder (shown with Apple iPhone SE)  
 RAM-B-273, RAM® Add-A-Ball™ Accessory  
 RAM-B-201-A, Short Double Socket Arm  
 RAM-B-202-GA63, Garmin VIRB™ Camera Adapter



---

# Device Holders & Adapters



Seen in this photo:  
RAM-B-149Z-A-UN12W-V7M, RAM® Tough-Charge™ Wireless Charging Motorcycle Mount with Charger (shown with Apple iPhone XS)



# Device Holders & Adapters

## RAM® Tough-Charge™ with X-Grip® Technology

The RAM® Tough-Charge™ with X-Grip® Technology is the world's first patented, universal waterproof wireless charging cradle for phones. Designed with spring-loaded RAM® X-Grip® Technology, this cradle features an 'X' design that expands and contracts to secure nearly any phone while taking advantage of wireless charging via the Qi standard. For added security and peace of mind, a safety tether is included that's recommended for outdoor applications. On the bottom of the cradle, a support leg can be adjusted to the ideal position or removed altogether. Available in a variety of mounting kits, ensure wireless charging capabilities across a wide range of vehicles.



**WATER  
PROOF**



\*Safety tether included for rugged and outdoor applications

### RAM-HOL-UN12WB

- Minimum Width: 2.375" (Minimum Height = 3.375"), Maximum Width = 3.25" (Minimum Height = 2.25"), Depth = 0.875"
- 1" Ball (B)



**WATER  
PROOF**



\*Safety tether included for rugged and outdoor applications

### RAM-HOL-UN14WB

- Height Range: 5.625" – 6.75", Max Width: 3.125", Max Depth: 0.70"
- 1" Ball (B)

See page 48 for Power Accessories

## Device Holders & Adapters



Seen in this photo:  
RAM-B-149Z-A-PD4U, RAM® Quick-Grip™ XL Phone Mount with Handlebar U-Bolt Base (shown with Apple iPhone XS)



# Device Holders & Adapters

## RAM® Quick-Grip™

Capable of holding a broad range of electronics, the spring-loaded grips provide a secure fit for anything from phones to GPS devices. Take advantage of efficient one-handed placement and removal of your device.

Height Range	Width Range	Compatible Ball
4.75" - 5.75"	1.25" - 3.25"	RAM-B-238

## RAM® Quick-Grip™ XL

This version of the spring-loaded RAM® Quick-Grip™ holder provides a secure fit for a variety of large phones and other devices. The adjustable side keepers ensure that devices like GPS units and Bluetooth speakers within the listed compatible dimensions will also fit in the holder.

Height Range	Width Range	Compatible Ball
5.75" - 7.25"	2.625" - 3.625"	RAM-B-238

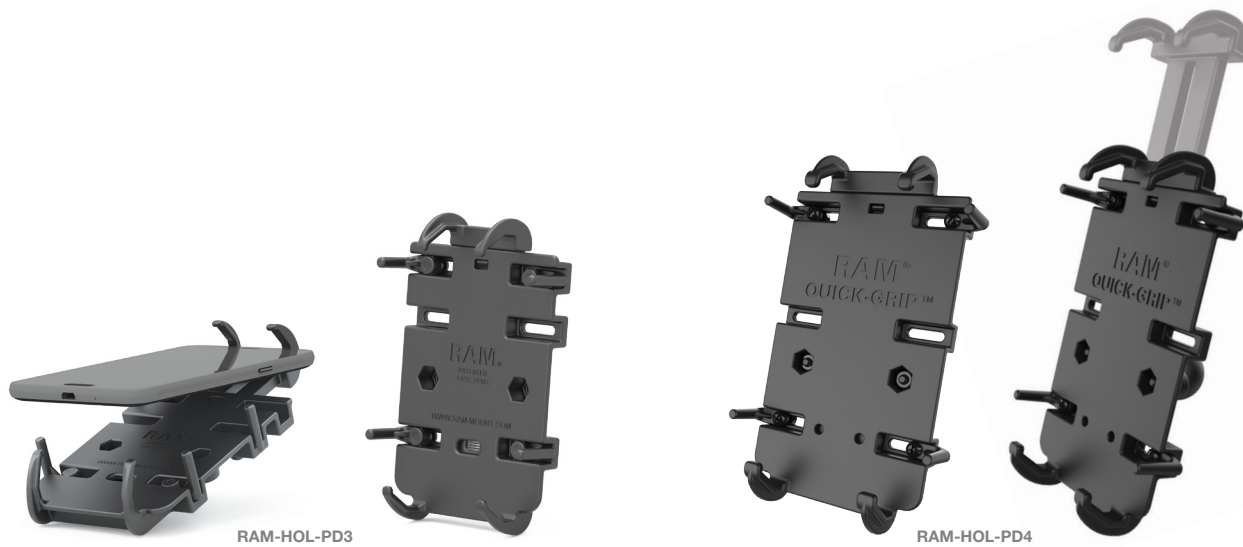

Seen in this photo:  
RAM-B-149Z-A-PD3, RAM® Quick-Grip™ Phone Mount with Handlebar U-Bolt Base



## Device Holders & Adapters



Seen in this photo:  
RAM-B-149Z-UN10, U-Bolt Handlebar Mount With RAM® X-Grip® Phone Holder (shown with Apple iPhone 6)

# Device Holders & Adapters

## RAM® X-Grip®

The RAM® Mounts X-Grip® keeps your device secure and accessible, whether suctioned to your windshield or drilled to your console. The unique design of the RAM® X-Grip® means it can support almost any sized phone with or without a case or sleeve.



**RAM-HOL-UN7B**  
Fits phones up to 3.25" wide



**RAM-HOL-UN10B**  
Fits phones up to 4.5" wide



**RAM-HOL-UN7TU**

## Safety Tether (Included)

Ensure added peace of mind with the RAM® X-Grip® Tether, keeping your mounted device safe from excessive wind and G-force. In addition, it adds stability and vibration control when recording video.



Seen in this photo:  
RAM-B-149Z-UN7, U-Bolt Handlebar Mount with RAM® X-Grip® Phone Holder (shown with Samsung Galaxy S5)



# Device Holders & Adapters

## RAM® Finger-Grip™ Universal Holder

This versatile mount features three sets of sturdy flexible fingers that wrap around the device to secure it in the cradle—keeping hold of your device even in the roughest terrain. This cradle is designed to keep radios, GPS devices, phones and more at your fingertips.



RAM-HOL-UN4



RAM-B-238  
Ball Adapter (sold separately)



Seen in this photo:  
RAM-B-149Z-UN4, U-Bolt Handlebar Mount With RAM® Finger-Grip™ Device Holder (shown with radio)



# Device Holders & Adapters

## Form-Fit Holders

These form-fit cradles provide a secure fit for your device, and are RAM® Mounts Compatible™ with AMPS hole pattern bases so you can easily attach double socket arms and a wide variety of mounts.

Part Number	Device	Compatible Ball
RAM-HOL-AP18	Apple iPhone 6 & 7	RAM-B-238
RAM-HOL-AP19	Apple iPhone 6 Plus & 7 Plus	RAM-B-238
RAM-HOL-AP25	Apple iPhone X & XS	RAM-B-238
RAM-HOL-AP26	Apple iPhone XR	RAM-B-238
RAM-HOL-AP28	Apple iPhone 11	RAM-B-238
RAM-HOL-AP29	Apple iPhone 11 Pro	RAM-B-238
RAM-HOL-AP30	Apple iPhone 11 Pro Max	RAM-B-238
RAM-HOL-SPO5	SPOT X	RAM-B-238 RAM-238



RAM-HOL-AP28  
iPhone 11



RAM-HOL-AP29  
iPhone 11 Pro



RAM-HOL-AP30  
iPhone 11 Pro Max



RAM-HOL-AP26  
iPhone XR



RAM-HOL-SPO5  
SPOT X



Seen in this photo:  
RAM-HOL-SPO5, RAM® EZ-Roll™ Cradle for SPOT X™

## Device Holders & Adapters



Seen in this photo:  
RAM-B-408-112-15-A-GOP1U, RAM® Torque™ Handlebar Mount With Short Double Socket Arm and Universal Action Camera Adapter (shown with GoPro® HERO 5)



# Device Holders & Adapters

## Action Camera Adapters

Capture the best photos and video possible with the help of RAM® Mounts camera ball adapters, allowing for the perfect angle and a secure hold. Constructed with the highest quality materials, the RAM® ball design dampens shock and vibration so you always get the shot.



RAP-B-202-GOP1



RAP-B-379-252025



RAP-B-202U-GOP2



RAP-B-GOP2-A-GOP1

## GoPro® Base Adapter

Specifically designed for GoPro® action cameras, this base adapter replaces the factory mount. Combine it with a RAM® Mounts arm and a two-pronged universal action camera adapter to allow for easily adjustable 360 degree rotation of your camera.



Seen in this photo:  
RAP-B-GOP2-A-GOP1, GoPro® Base Adapter With Short Double Socket Arm and Universal Action Camera Adapter (shown with Garmin VIRB® XE)



## Device Holders & Adapters

---

### RAM® Level Cup™

This self-leveling cup holder is the perfect accessory for motorcycles, ATVs and more. With two independent self-leveling hinge points that freely swivel, keep your beverage from spilling while taking any rough turns. Ideal for cans and small drinks up to 16oz.



RAM-B-132B

---

### Popular Kits

Choose the kit that works best for your desired mounting location – from dependable rail bases to the brake/clutch reservoir base.



RAM-B-132-400  
RAM® Tough-Claw™ Mount



RAM-B-408-75-1-A-132U  
RAM® Torque™ Mount



RAM-B-132R  
U-Bolt Mount



RAM-B-174-A-132  
Brake/Clutch Reservoir Mount



Seen in this photo:  
RAM-B-132-400, RAM® Tough-Claw™ Mount with RAM® Level Cup™ Drink Holder

# Device Holders & Adapters

## RAM® Level Cup™ XL

Utilizing similar features to the original RAM® Level Cup™, the RAM® Level Cup™ XL integrates an adjustable height option for accommodating much larger drink sizes, such as tumblers and water bottles. Whether you have a Nalgene, Pelican, Contigo or Hydro Flask, the RAM® Level Cup™ XL will secure most 32oz containers.



RAP-B-417B  
Ball Adapter



RAM-B-417-200-1U  
Socket Arm

## Popular Kits

Take advantage of popular rail base kits for the RAM® Level Cup™ XL, or use your existing base with the ball adapter and socket arm kits.



RAP-B-417-400  
RAM® Tough-Claw™ Mount



RAM-B-408-75-1-A-417  
RAM® Torque™ Mount



RAM-B-174-A-417  
U-Bolt Mount



Seen in this photo:  
RAM-B-408-112-15, RAM® Torque™ Rail Base  
RAM-B-201-A, Short Double Socket Arm  
RAP-B-417B, RAM® Level Cup™ XL Drink Holder



## Device Holders & Adapters



Seen in this photo:  
RAM-B-149Z, U-Bolt Handlebar Mount  
RAP-S-KNOB3, RAM® Pin-Lock™ Security Knob  
RAM-HOL-GA61LU, Locking Cradle for the Garmin dezl™ 760 (shown with device)  
RAM-B-349, Threaded Ball Adapter  
RAM-B-201, Medium Double Socket Arm (shown with Doubletake Adventure Mirror Ball)

# Device Holders & Adapters

When you're on the road less traveled, having the right gear with you is integral to a safe journey. RAM® Mounts GPS cradles offer durability, versatility and vibration damping to help get you wherever you're going.

Part Number	Fits	Compatible Ball
RAM-HOL-SPO5U	SPOT X™	RAM-B-238
RAM-HOL-ZE6U	Zebra TC51, 52, 56 & 57	RAM-B-238
RAM-HOL-GA31	Garmin Approach G5 & Oregon Series	RAM-B-238
RAM-HOL-GA34	Garmin nüvi 13xx Series & 24xx Series	RAM-B-238
RAM-HOL-GA40	Garmin GPSMAP 73, 78, 78S & 78SC	RAM-B-238
RAM-HOL-GA41	Garmin GPSMAP 62 & 64 Series	RAM-B-238
RAM-HOL-GA46U	Garmin Montana 600, 650 & 680	RAM-B-238
RAM-HOL-GA50	Garmin nüvi 50 & 50LM	RAM-B-238
RAM-HOL-GA55U	Garmin nüvi 52 - 58 Series	RAM-B-238

Part Number	Fits	Compatible Ball
RAM-HOL-GA57U	Garmin nüvi 2557LMT & LT, 2597LMT & 2598LMT	RAM-B-238
RAM-HOL-GA66LU	Garmin fleet 660 & 670	RAM-B-238
RAM-HOL-GA67	Garmin nüvi 65, 66, 67 & 68	RAM-B-238
RAM-HOL-GA70LU	Garmin dezl 770LMTHD	RAM-B-238
RAM-HOL-GA71LU	Garmin dezl 570LMT	RAM-B-238
RAM-HOL-GA72U	Garmin nüvi 2689LMT	RAM-B-238
RAM-HOL-GA73U	Garmin nüvi 2589LMT	RAM-B-238
RAM-B-202-GA76U	Garmin Handheld Units with Spine Adapter	RAM-B-238 included
RAM-HOL-GA76U	Garmin Handheld Units with Spine Adapter	RAM-B-238



RAM-HOL-GA31



RAM-HOL-GA71LU



RAM-B-202-GA76U



Seen in this photo:  
 RAM-B-202-GA76U, Garmin Handheld Units with Spine Adapter  
 RAM-B-201U-A, RAM® Double Socket Arm  
 RAM-B-367U, RAM® Motorcycle Handlebar Clamp Base with M8 Bolts



# Device Holders & Adapters

## RAM® Power Plate™ III Radar Detector Holder

Designed to hold radar detectors and other devices, the RAM® Power Plate™ III features magnets and a metal plate that attaches to the bottom of your radar detector.

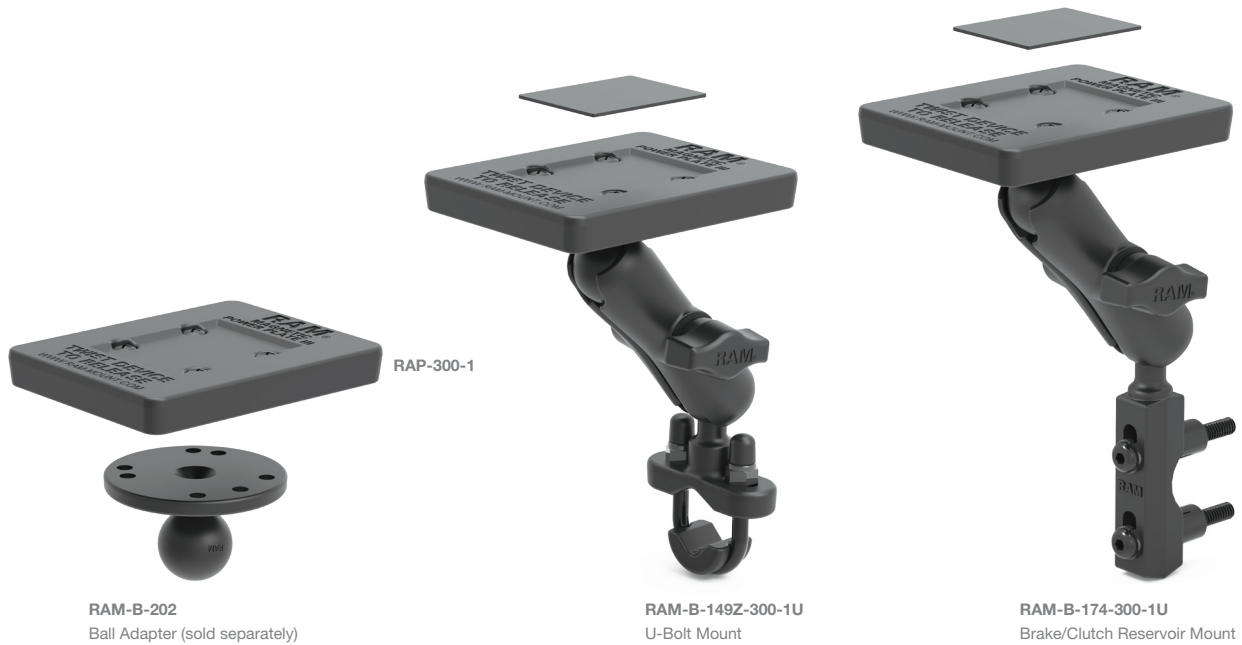

Seen in this photo:  
RAM-B-345, Centered Reservoir Cover Base  
RAM-B-201, Medium Double Socket Arm  
RAM-B-202, AMPS Round Device Adapter  
RAP-300-1, RAM® Power Plate™ III Radar Detector Holder (shown with Valentine One)

# Device Holders & Adapters

## IntelliSkin® with GDS®

Keep your device charged wherever the road takes you. From IntelliSkin® sleeves to GDS® Docks™, these solutions for a variety of phones offer a complete mounting and charging system.

Part Number	Device
RAM-GDS-SKIN-SAM28	Samsung Galaxy S8
RAM-GDS-SKIN-SAM32	Samsung Galaxy J7 (2017)
RAM-GDS-SKIN-SAM37	Samsung Galaxy Xcover 4
RAM-GDS-SKIN-SAM39	Samsung Galaxy S9
RAM-GDS-SKIN-SAM42	Galaxy Note 9
RAM-GDS-SKIN-SAM44	Galaxy J3 (2018)
RAM-GDS-SKIN-SAM45	Galaxy J7 (2018)
RAM-GDS-SKIN-SAM51	Galaxy Xcover 4s

Part Number	USB Type
RAM-GDS-DOCK-V1U	Micro USB 2.0
RAM-GDS-DOCK-V1CU	USB Type C

IntelliSkin® HD™ with GDS®	
Part Number	Device
RAM-GDS-SKIN-SAM39HD	Galaxy S9





---

# Power Accessories



Seen in this photo:  
RAM-B-149Z-A-UN14W-V7M, RAM® Quick-Grip™ Waterproof Wireless Charging Handlebar Mount

# Power Accessories

Choose from a variety of power options for your wireless cradle and GDS®-enabled dock, including a huge range of charger types.

Part Number	Charger Type	Input Range	Output	Output Connector Type	Compatible Devices
RAM-GDS-CHARGE-USB2QCCIG	2 port cig charger with Quick Charge support	12-18VDC	Port 1: Quick Charge 3.0(18W) Port 2: 5V/2.4A (12W) 30W Max	2 Qty USB-A Female	Any 5V device with a current requirement of 2.4A or less
RAM-GDS-CHARGE-V7BU	USB Type-A hardwire	8-40VDC	5VDC & 9VDC (QC only) 2.5A Max	1.2M cable with USB-A Female	Any 5V device with a current requirement of 2.5A or less. Includes support of Apple iOS 2.1/2.4A devices and support for Qualcomm Quick Charge 2.0/3.0 devices
RAM-GDS-CHARGE-V7-M55U	DC cable hardwire	8-40VDC	5VDC 2.5A Max	1.2M cable with DC cable	Any 5V device with a current requirement of 2.5A or less
RAM-GDS-CHARGE-V7-MUSBU	mUSB hardwire	8-40VDC	5VDC & 9VDC (QC only) 2.5A Max	1.2M cable with Micro-B USB Male	Any 5V device with a current requirement of 2.5A or less. Includes support of Apple iOS 2.1/2.4A devices and support for Qualcomm Quick Charge 2.0/3.0 devices
RAM-GDS-CHARGE-V7-USBCU	USB Type-C hardwire	8-40VDC	5VDC & 9VDC (QC only) 2.5A Max	1.2M cable with USB-C Male	Any 5V device with a current requirement of 2.5A or less. Includes support for Qualcomm Quick Charge 2.0/3.0 devices
RAM-CHARGE-V7MU	USB Type-A hardwire	8 - 18VDC	5-9VDC 2.5A Max	1.2M cable with USB-A Female	Any 5V device with a current requirement of 2.5A or less
RAM-GDS-CHARGE-V3CU	USB Type-C hardwire	12-24VDC	5V/3A; 9V/3A; 12V/3A 37.5W Max	1.2 M cable with USB-C Male	Any device supporting Power Delivery 2.0 up to 36W
RAM-GDS-CHARGE-CIGC	GDS® Type-C and Type A 2-Port Cigarette Charger	12-24V DC	USB-A Output : 5V/3A, 9V/2A, 12V/1.5A. USB 2.0 BC 1.2 5V/1.67A, Apple iOS 2.1A and 2.4A support, Qualcomm QC 3.0 on both Type A and Type C up to 18W each. Type C Power Delivery 3.0:5V/3A, 9V/3A, 12V/3A, 15V/3A, 20V/2A Max 63W (45W for Type-C & 18W for Type-A)	1 QTY Type-C Female (Power Delivery) & 1 QTY Type-A Female (QC 3.0), USB-A: Any 5V, 9V or 12V device with a current requirement of 18W or less. Includes support for Qualcomm Quick Charge 2.0 devices and Apple iOS 2.1A and 2.4A	USB-C: Devices supporting USB 3.1 Power Delivery 3.0 up to 20V/2A.
RAM-GDS-CHARGE-V3CAU	GDS® Hardwire Charger with USB Type C Male Connector and USB Type A Port	12V - 24V DC	5V- 15VDC 3A Max	Male Type-C with Female Type-A	Supports any USB-C Device that uses the USB 3.1 PD2.0 standard or higher, with max power up to 36W (5V/3A, 9V/3A, 12V/3A, 15V/2.5A)



RAM-GDS-CHARGE-USB2QCCIG



RAM-CHARGE-V7MU



---

# Scooters

RAM® Mounts offers several mirror base mounting solutions, including the RAM® Torque™ mini rail base. Paired with popular cradles like the RAM® X-Grip®, easily secure your phone and other devices.





---

# ATV/Side-by-Sides

In addition to the large version of the RAM® Torque™ base for handlebars and rails, the RAM® Tough-Track™ is an ideal track solution for ATVs and side-by-sides. Compatible with a wide variety of RAM® track bases for devices.





---

# Dirt Bikes

Capture all the action from your dirt bike with the RAM® universal action camera adapter. Compatible with a range of RAM® rail bases, simply attach any action camera – including GoPro® – that features a standard two-pronged attachment.





---

# Snowmobiles

For large rails and bars, trust the versatile RAM® Tough-Claw™ mount and universal action camera adapter to dampen shock and vibration. No tools are needed for installation and removal, so you can use the RAM® Tough-Claw™ wherever and whenever you need it.





# The Shape That Started It All

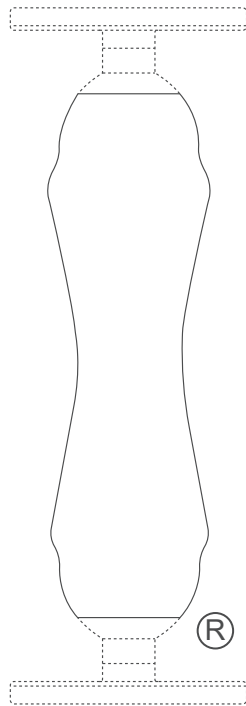

RAM® Mounts double socket arms—featuring a distinctive Hourglass Shape—are recognized globally as a symbol of durability, reliability and quality. The Hourglass Shape is a registered trademark of National Products Inc.

The unique RAM® Mounts system offers a full line of interchangeable mounting bases, extensions, device adapters and accessories to secure your gear where you want it. See all of the innovative products and solutions RAM® manufactures at [rammount.com](http://rammount.com).



The distinctive RAM® “X-Grip®” product shape is a trademark of National Products Inc.



The distinctive “D” product shape of the GDS® connector is a trademark of National Products Inc.



---

RAM® Mounts is a division of National Products Inc.

8410 Dallas Avenue South

Seattle, WA 98108

Phone: 800.497.7479

sales@rammount.com

rammount.com

Lifetime Warranty

Patents and Trademarks

rammount.com/ip





Contact Us  
sales@rammount.com  
1-800-497-7479

Join Our Community



NPI-CAT-POWSP018  
January 2020